

ANCHOR FLUID POWER

Mailing Address:

5553 Murray Road,
Cincinnati, OH 45227

Phone: 866.FLANGES

Fax: 513.527.4449

E-Mail: sales@anchorfluidpower.com

Website: www.anchorfluidpow.wpengine.com

ANCHOR FLUID POWER®

AN ANCHOR FLANGE COMPANY

Item # W37-16-16-S/S, 1.00 Inch (in) Pad Size CD61 Blanking 4-Bolt Stainless Steel Flange

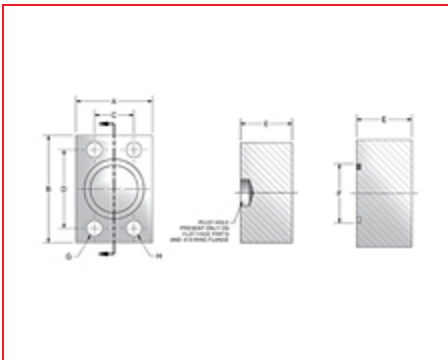

List Price -

Quote

Specifications -

Dimension Drawing

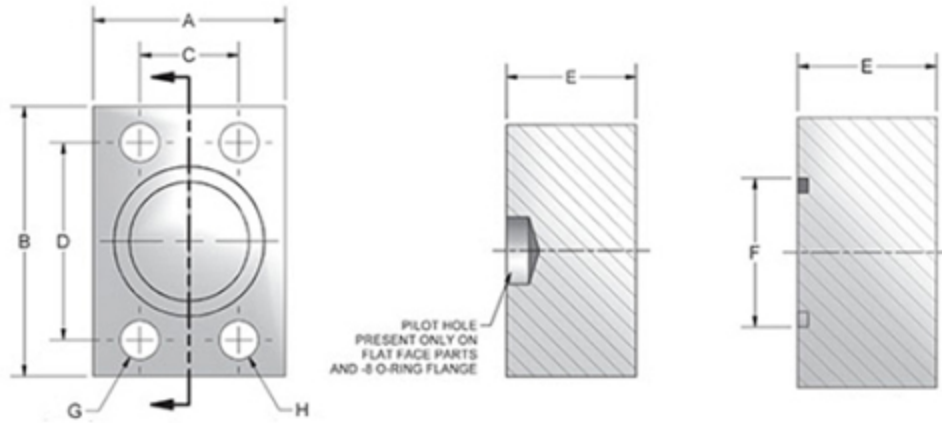

CD61/CD62 Blanking 4-Bolt Stainless Steel Flanges

Type	Flat Face
Material	Stainless Steel
Code	Code 61
Pad Size	1.00 in
Dimension A	2.00 in
Dimension B	2.820 in
Dimension C	1.031 in
Dimension D	2.063 in
Dimension E	1.450 in
Dimension H (UNC - 2B)	3/8-16

